

Back: Cut 1

Front: Cut 2

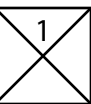

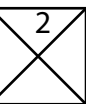

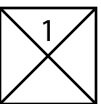
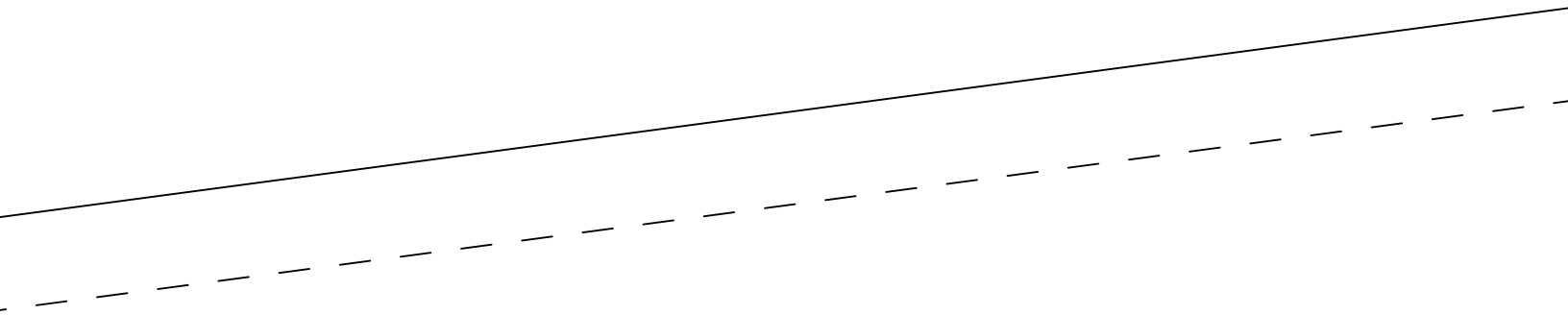
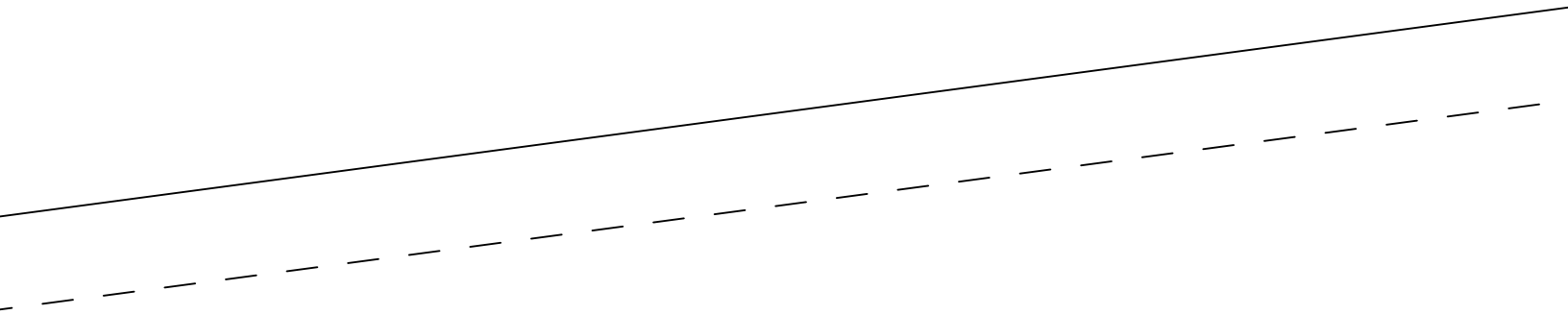
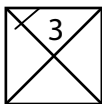
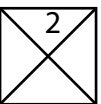
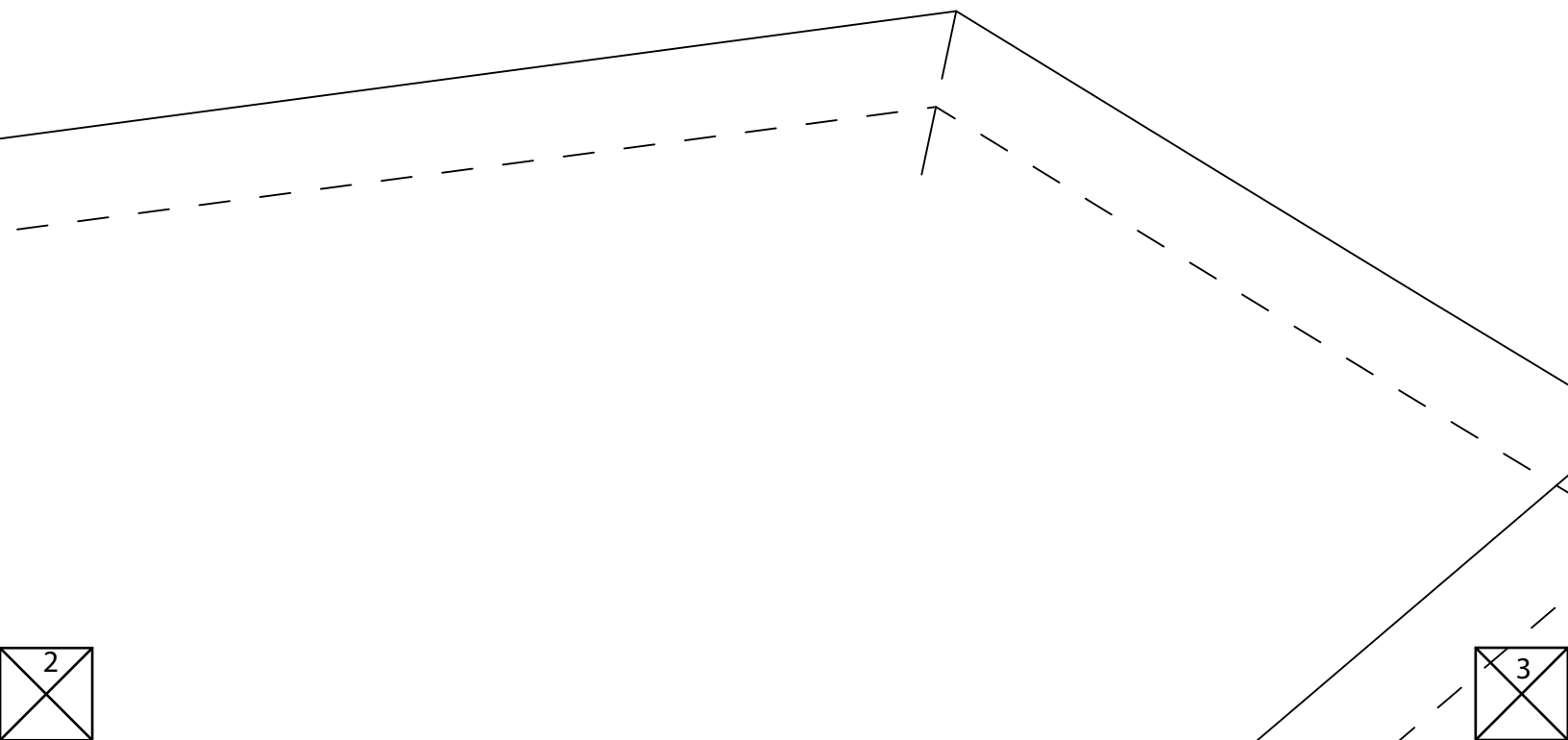
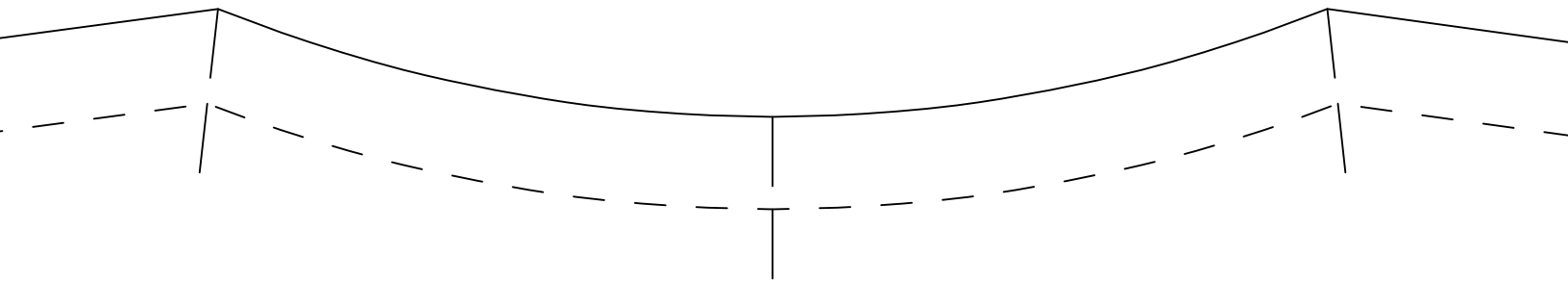

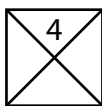
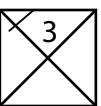
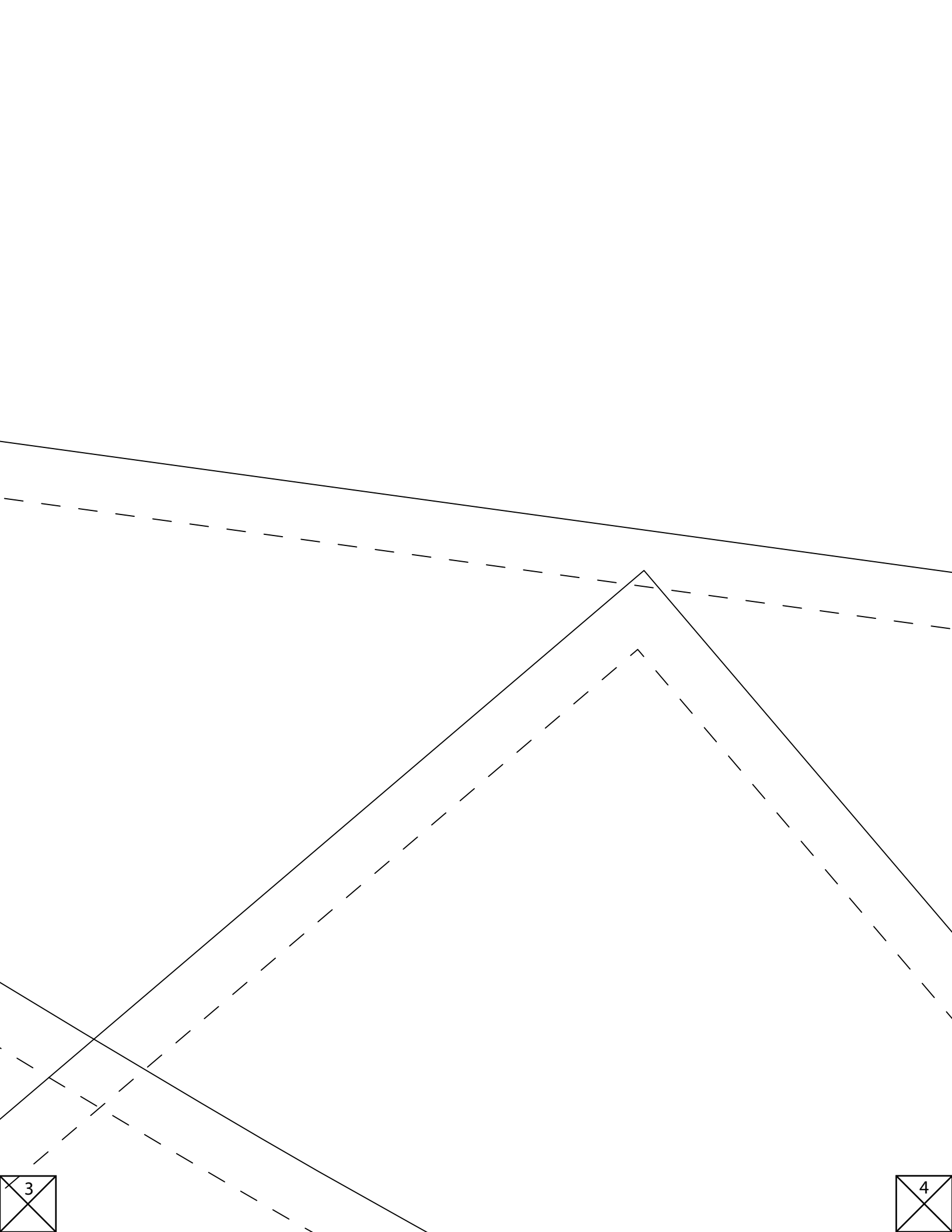

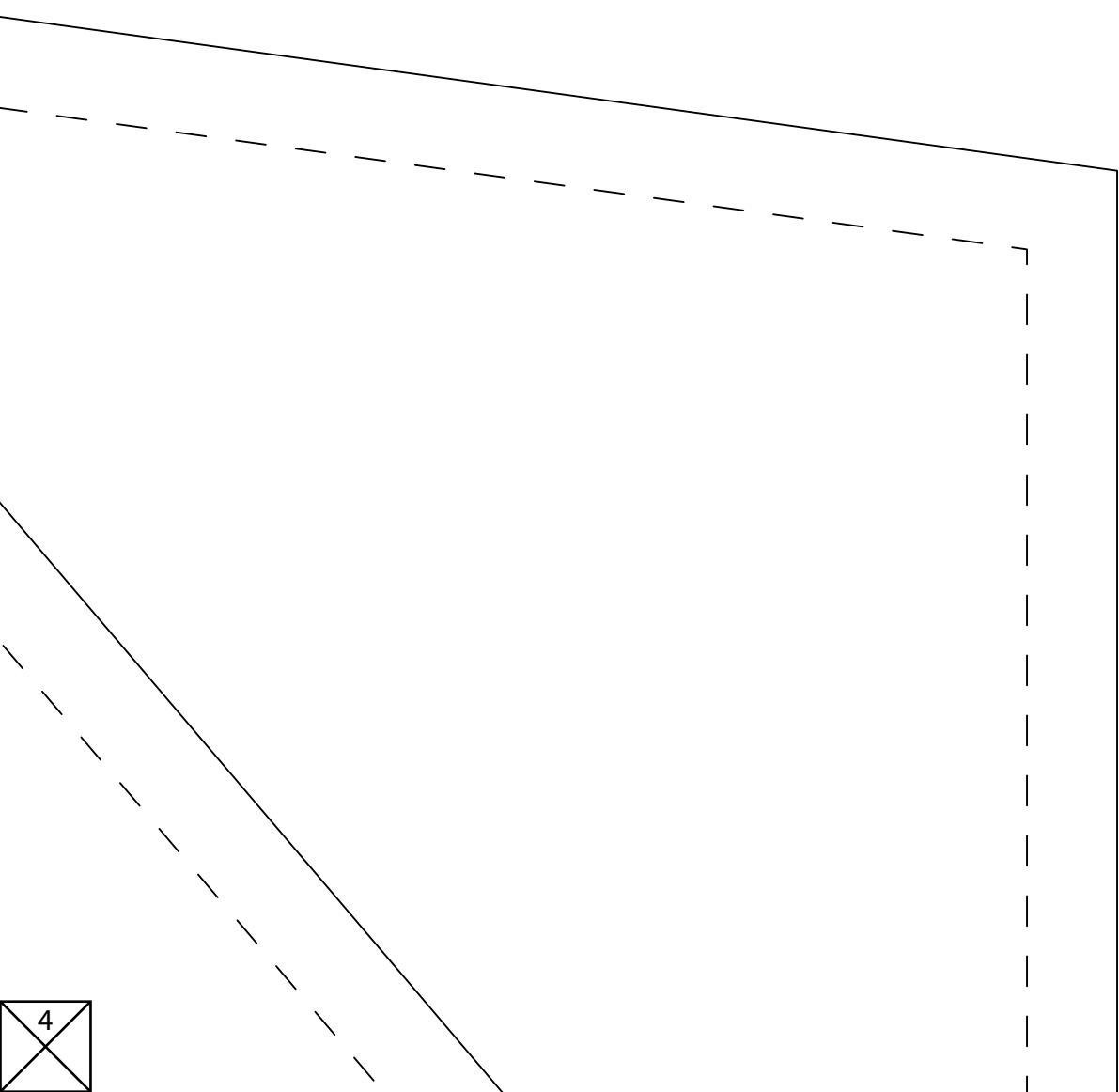

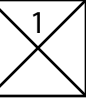

SE
D
H
TH
N
TH
TH
TH
A
O
ht
ht
A

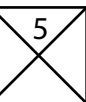

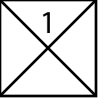

SEAM ALLOWANCES FOR THIS PATTERN: 1/2" except for the hood drawstring. Hood drawstring is 1". It is marked with a
DISCLAIMERS:

Hopefully you'll get the gist of the matter; we shouldn't have to hire a lawyer to write this stuff up.

This pattern is not to be sold or exchanged but you can distribute it freely with the hopes you and others will make co.

No expressed warranty of this pattern is implied. That said, it has been checked and double checked down to 1/64th" a

The design and instruction for the pattern of this coat project is by Carol Kimball & Carol Phillips.

Their site for this project which includes sewing instructions is <http://www.carolkimball.net/homeless-coat/>

There are also instructions there to draft your own pattern if you don't like this one.

This pattern print out was drafted by Kathleen Fasanella using StyleCAD software and further modified and edited in C

Additional thanks to Ann Vong and Jasonda Desmond.

Online discussion for this coat can be found:

<http://www.fashion-incubator.com/archive/a-homeless-coat-pattern/>

<http://fashion-incubator.com/phpbb/viewtopic.php?p=54667#54667>

Any questions or commentary regarding this project should be directed to carol.kimball@earthlink.net

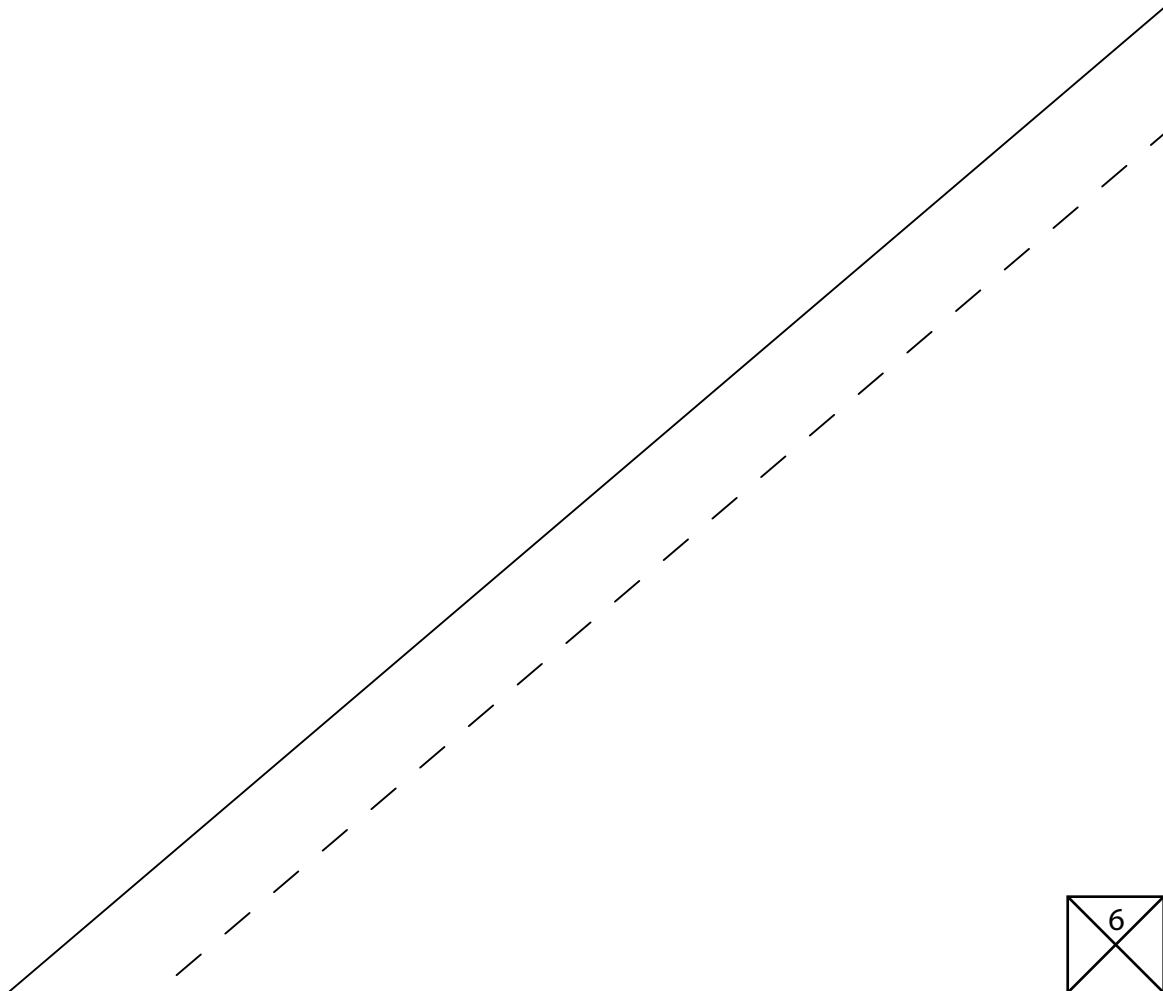
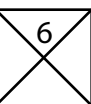
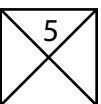

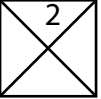

l with a dashed line.

ake coats for those less fortunate.
/64th" accuracy.

ted in CS5.

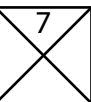
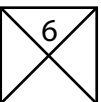
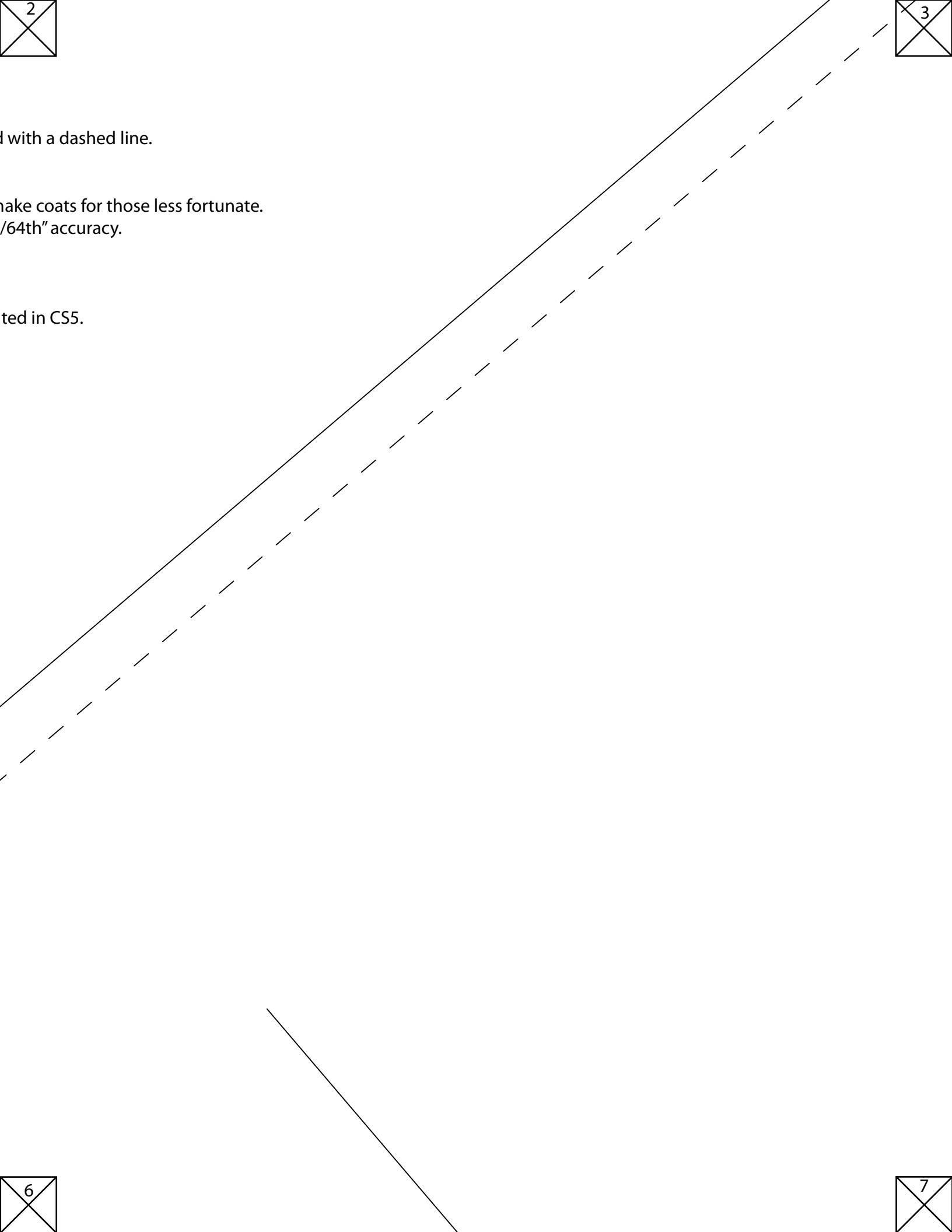

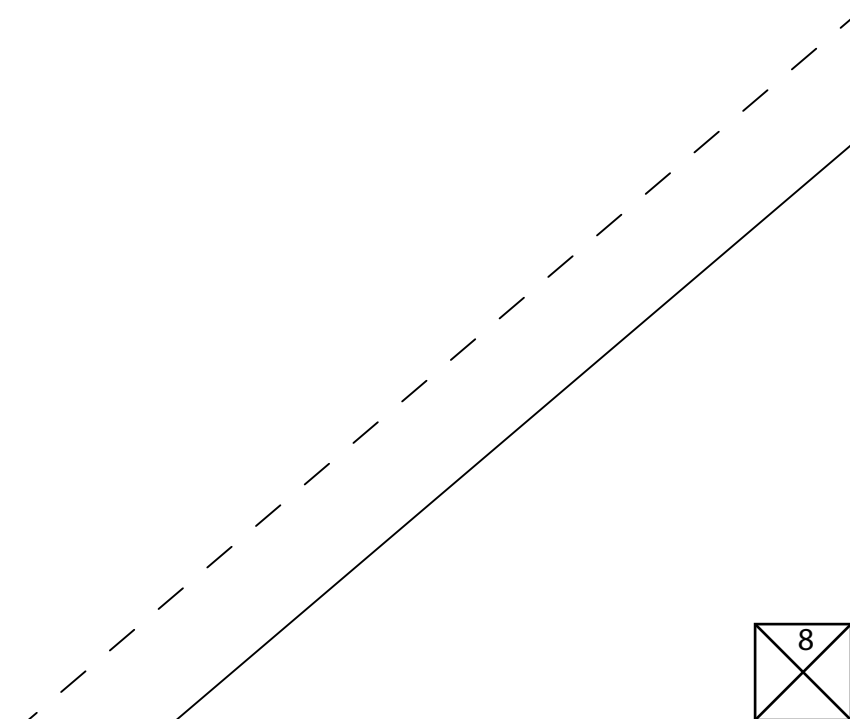
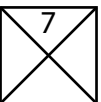
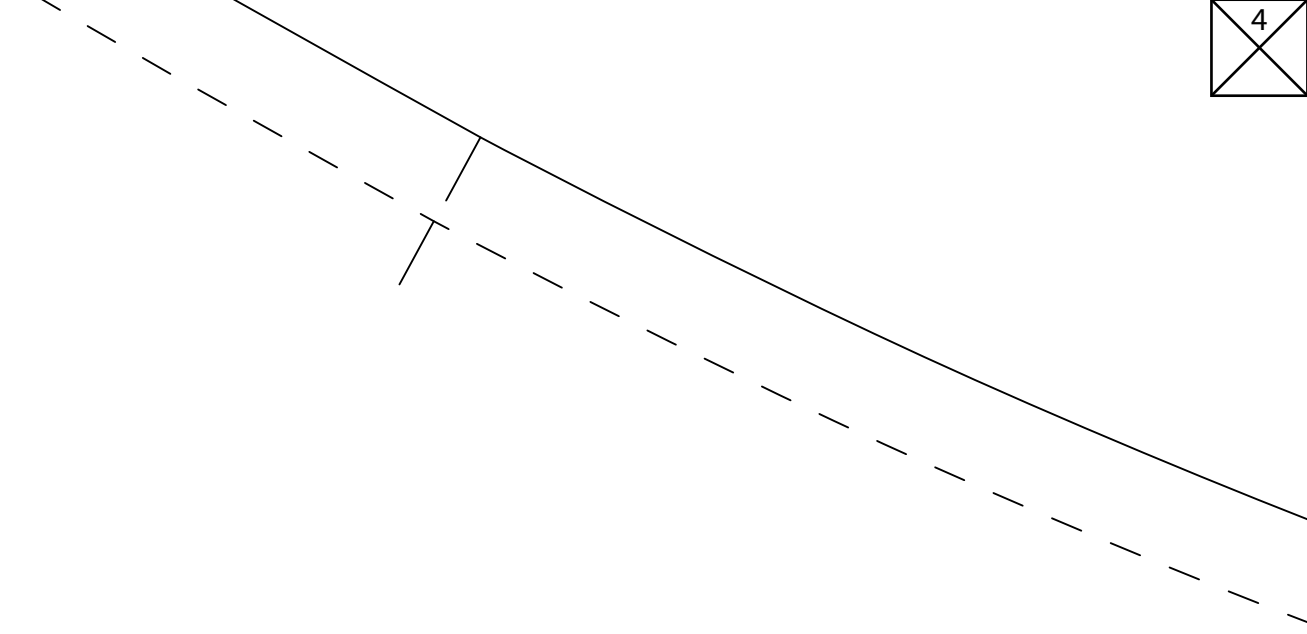
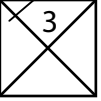

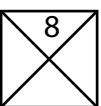
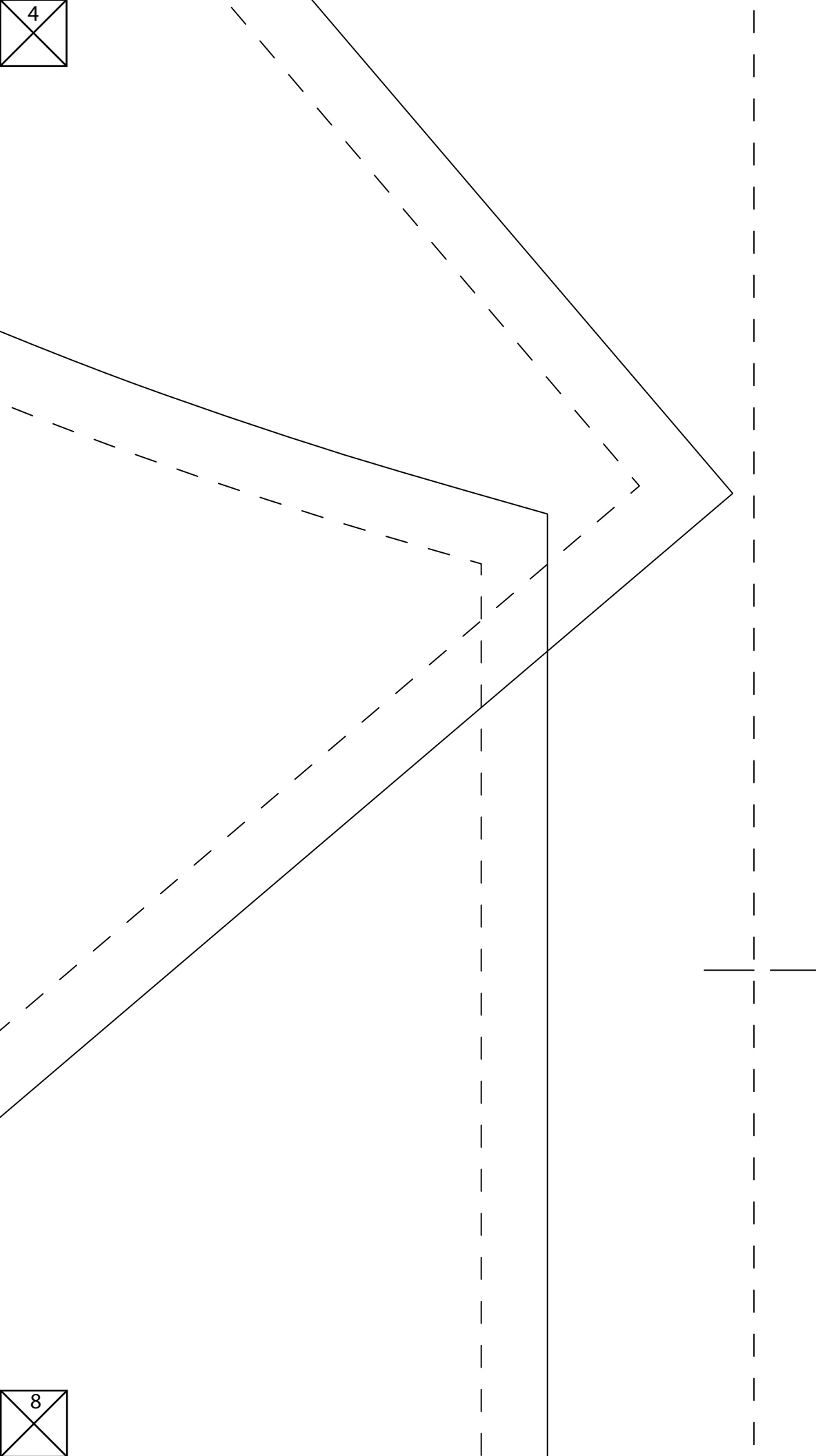
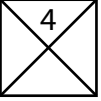

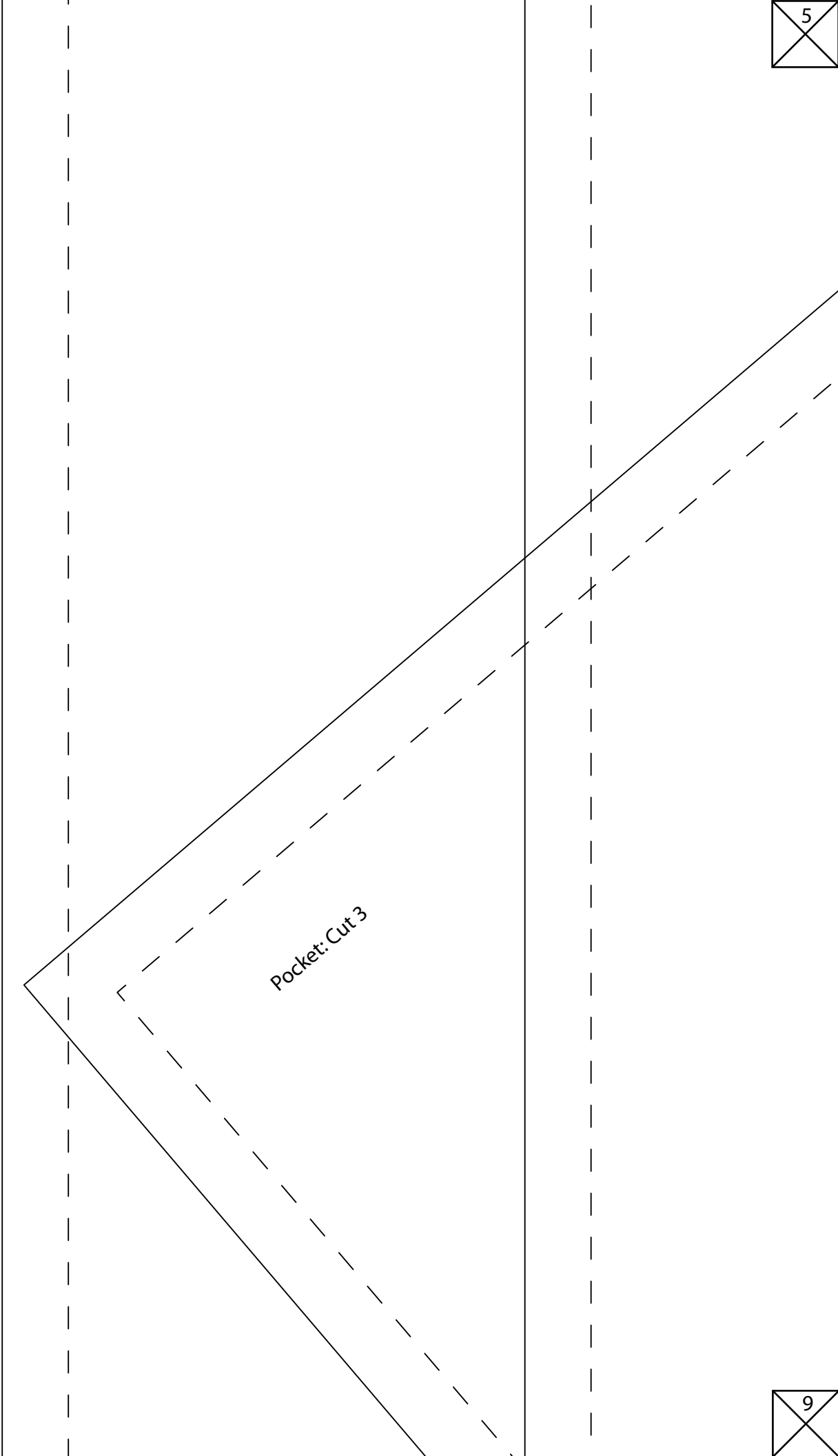

Pocket: Cut 3



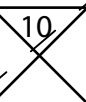
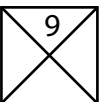
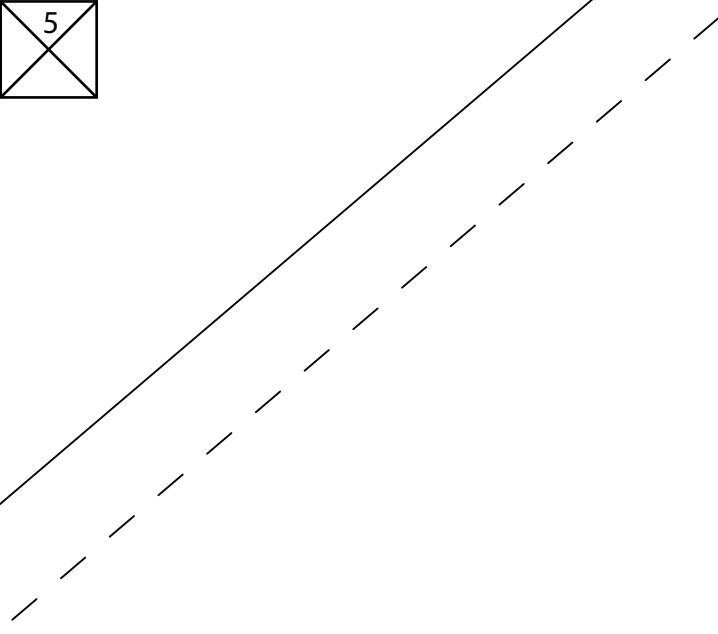
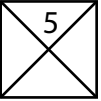

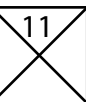
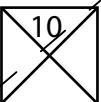
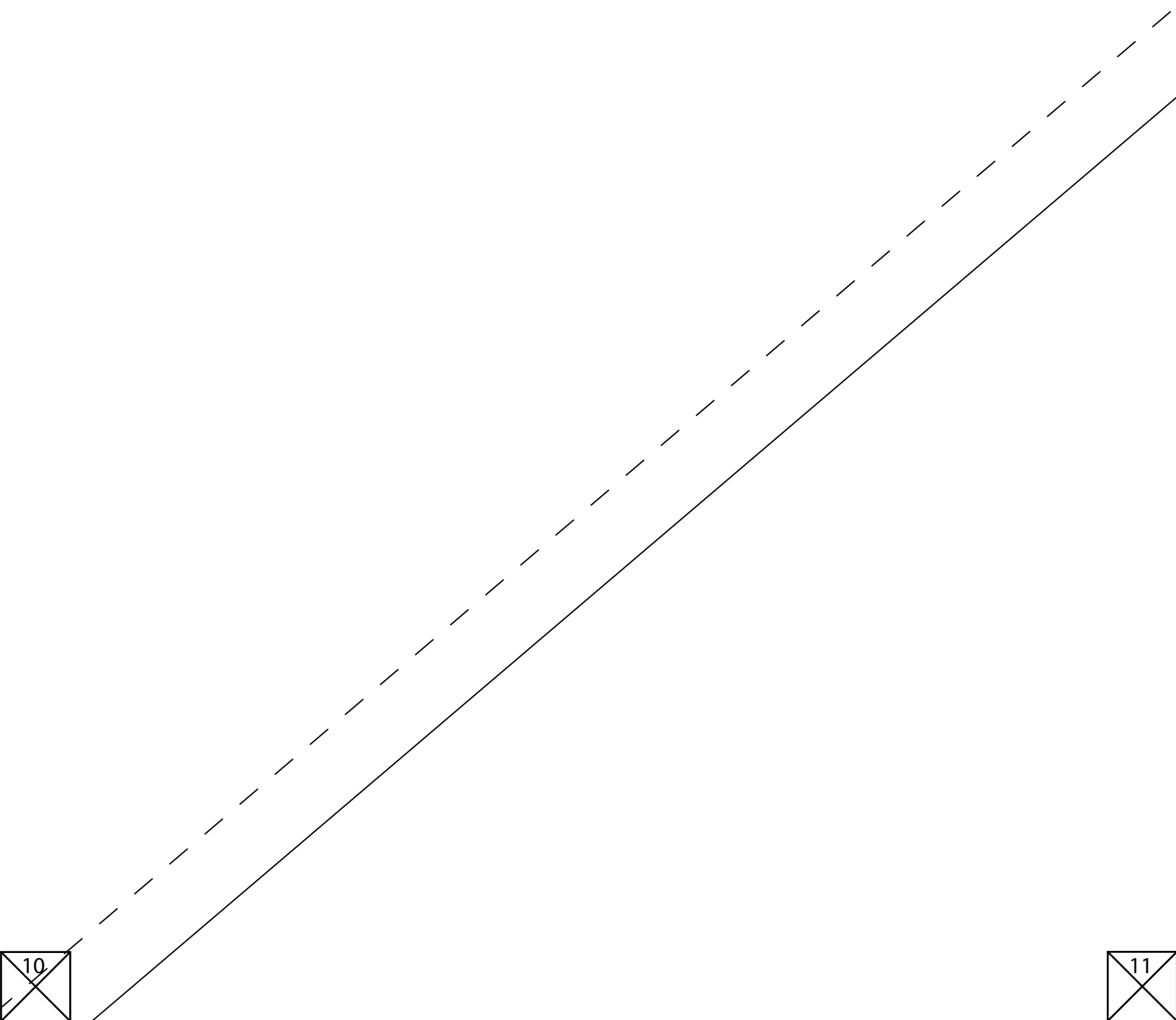
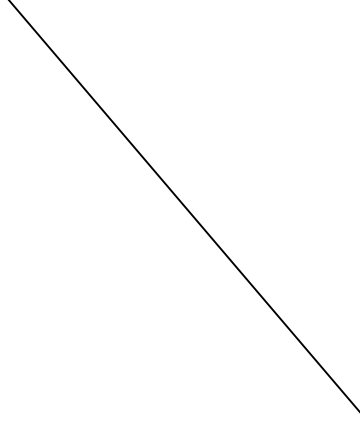
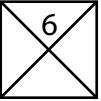

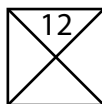
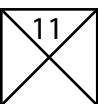
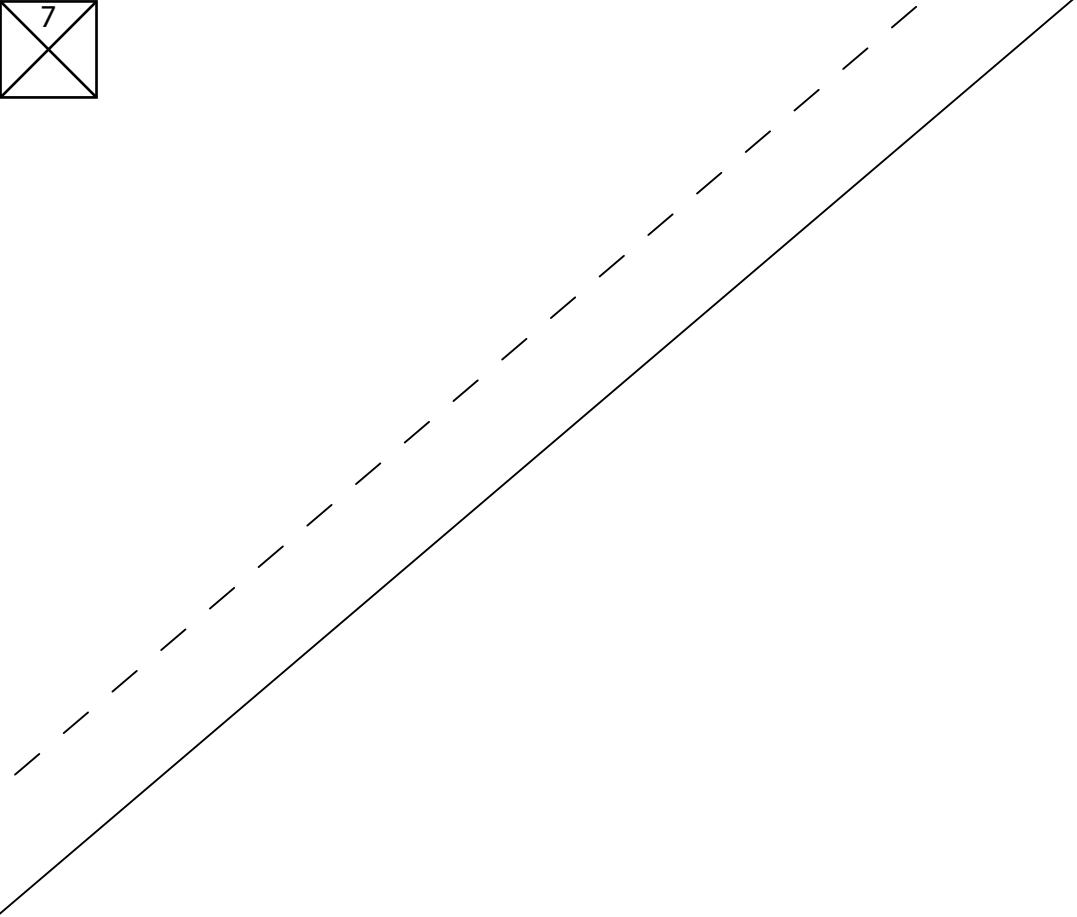
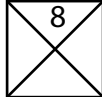

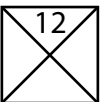
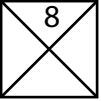

A vertical writing area consisting of a solid left line, a dashed middle line, and a solid right line.

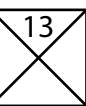
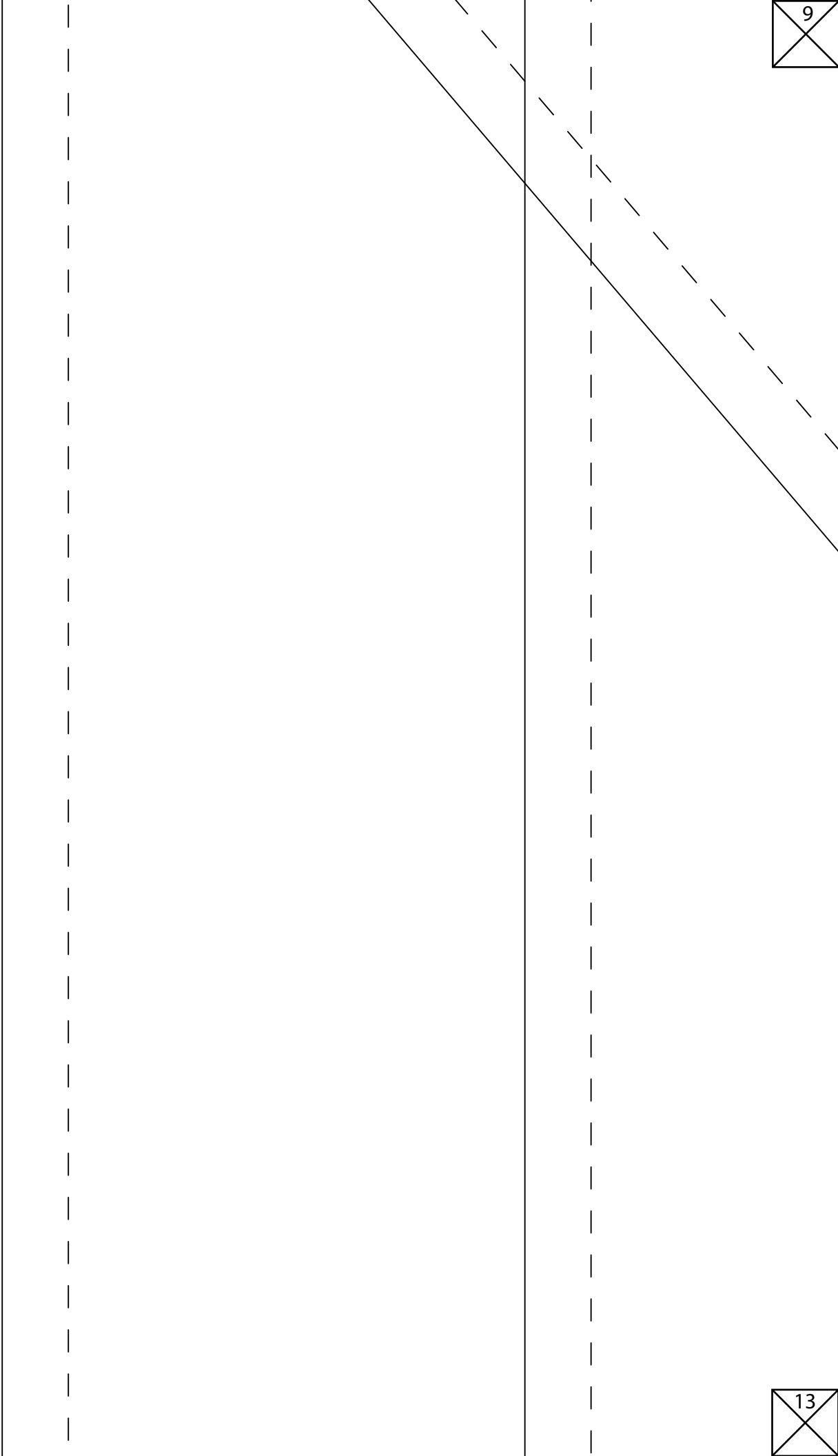

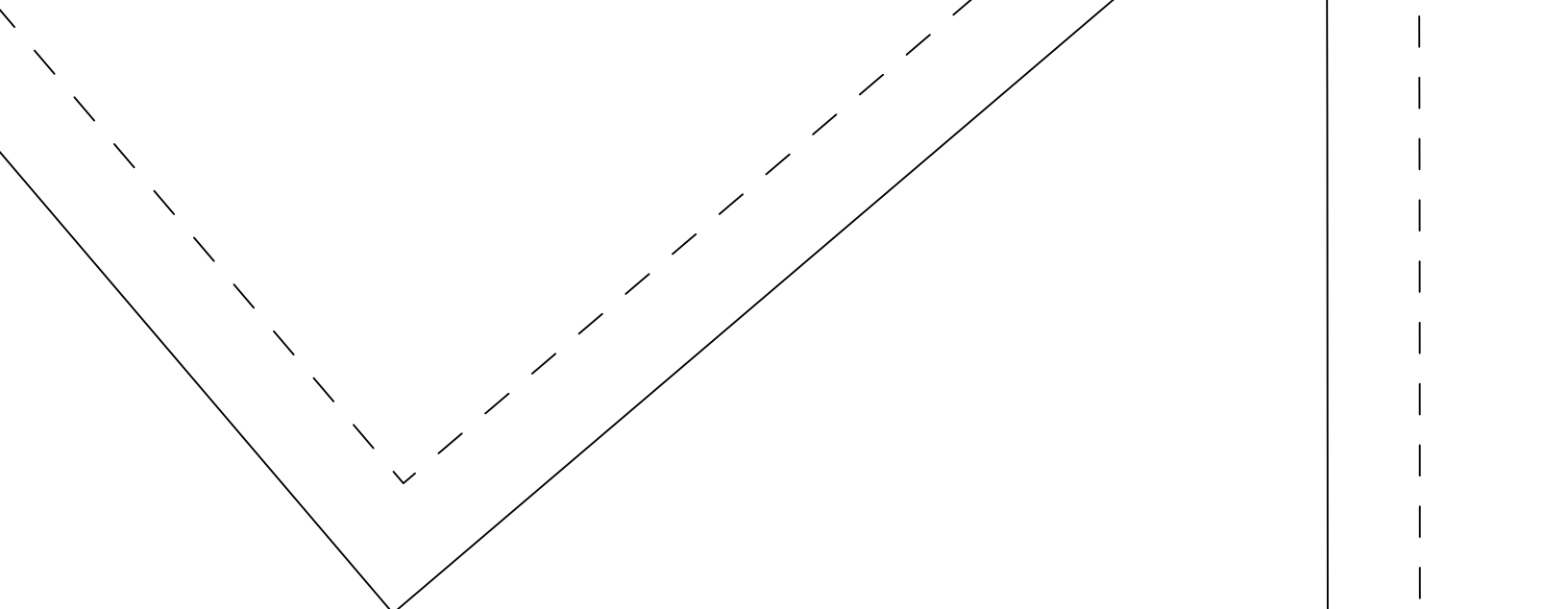
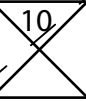

Sleeve: Cut 2

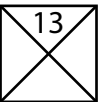

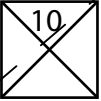

: Cut 2

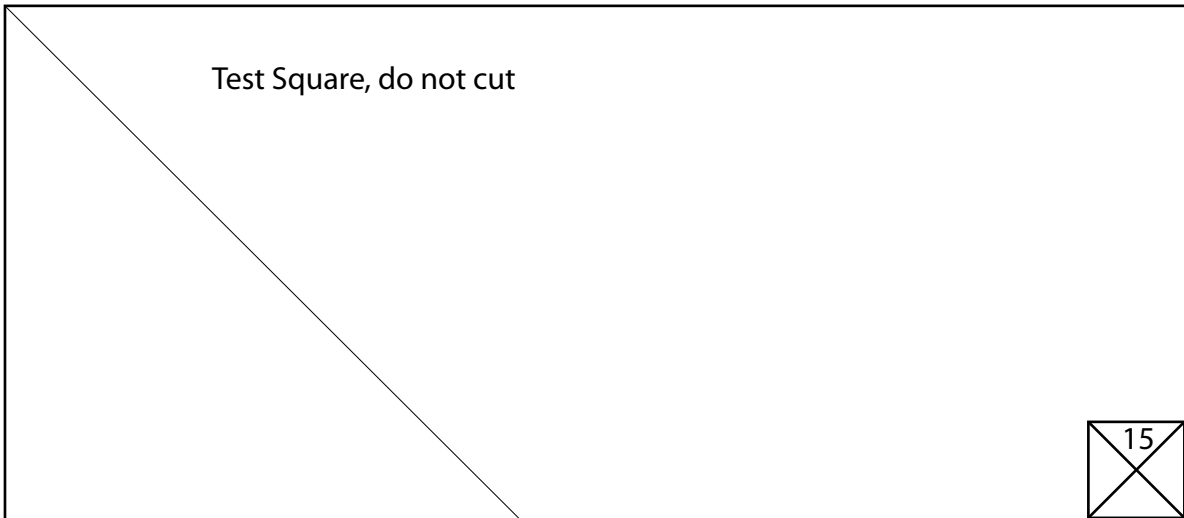

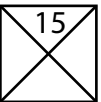
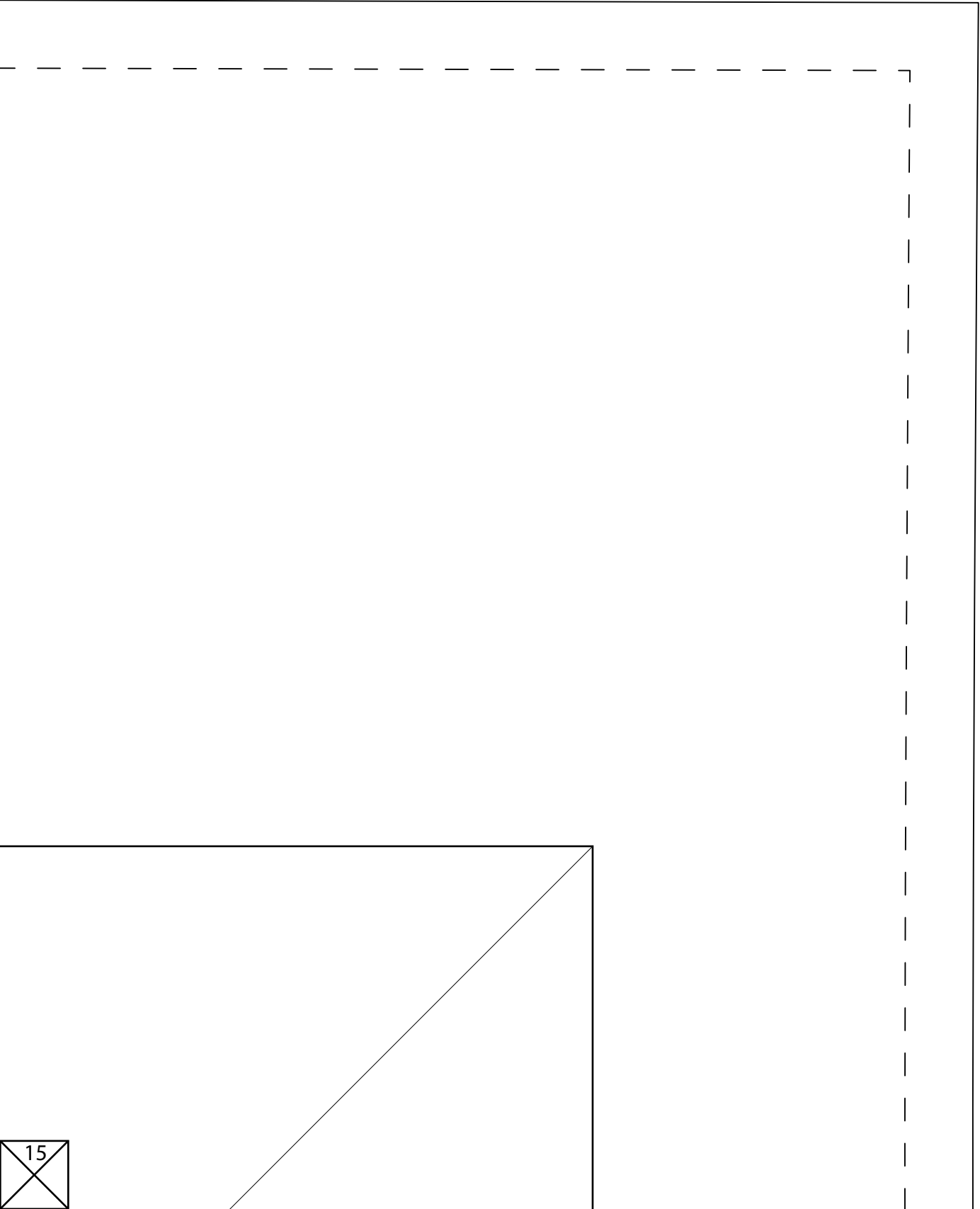

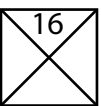
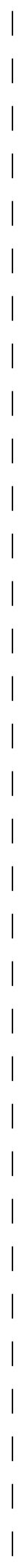
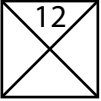

Blank writing area with two vertical dashed lines for alignment.

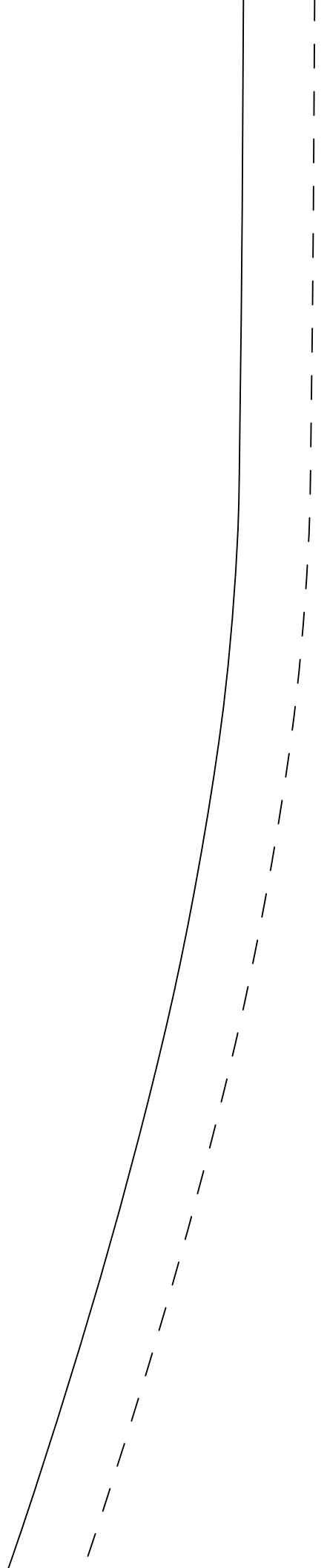
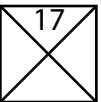
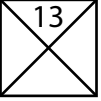



Test Square
10" by 10"

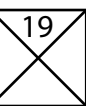
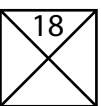

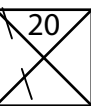
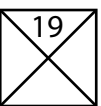
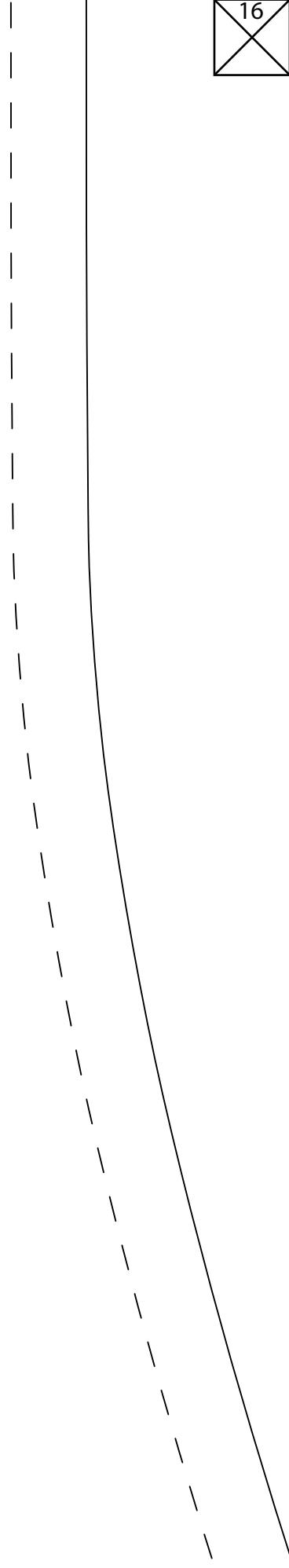
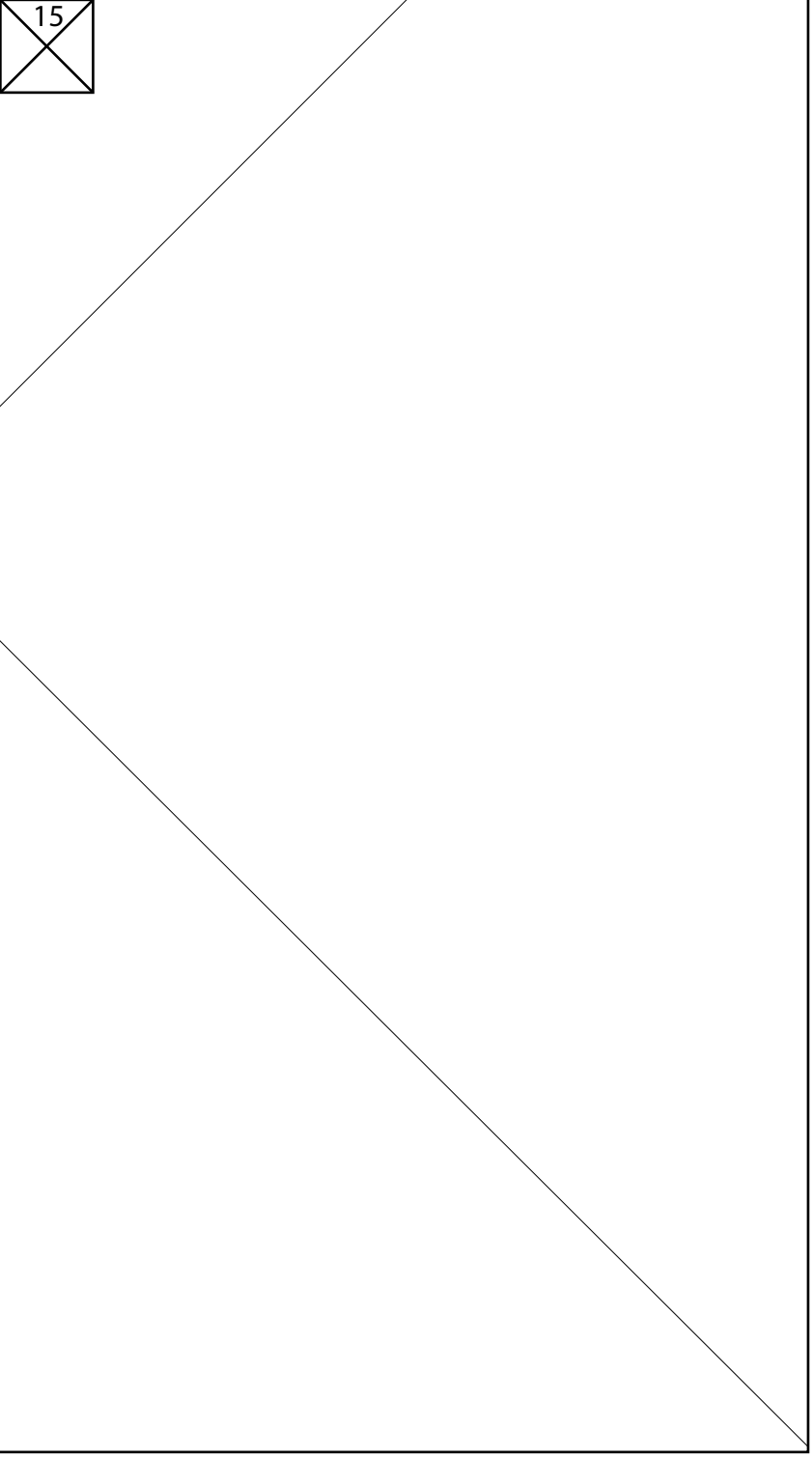
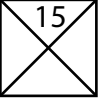

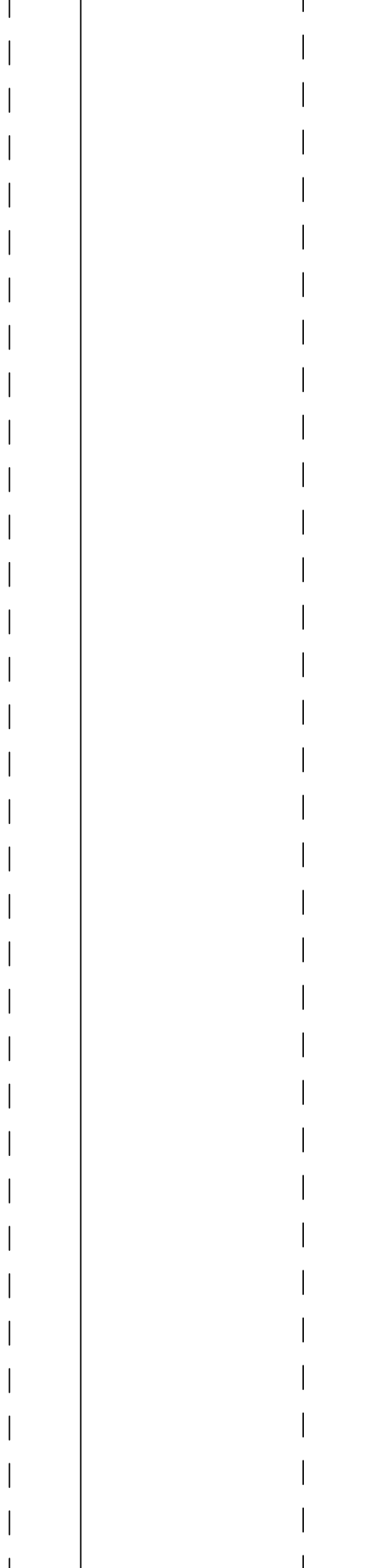
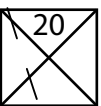
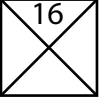

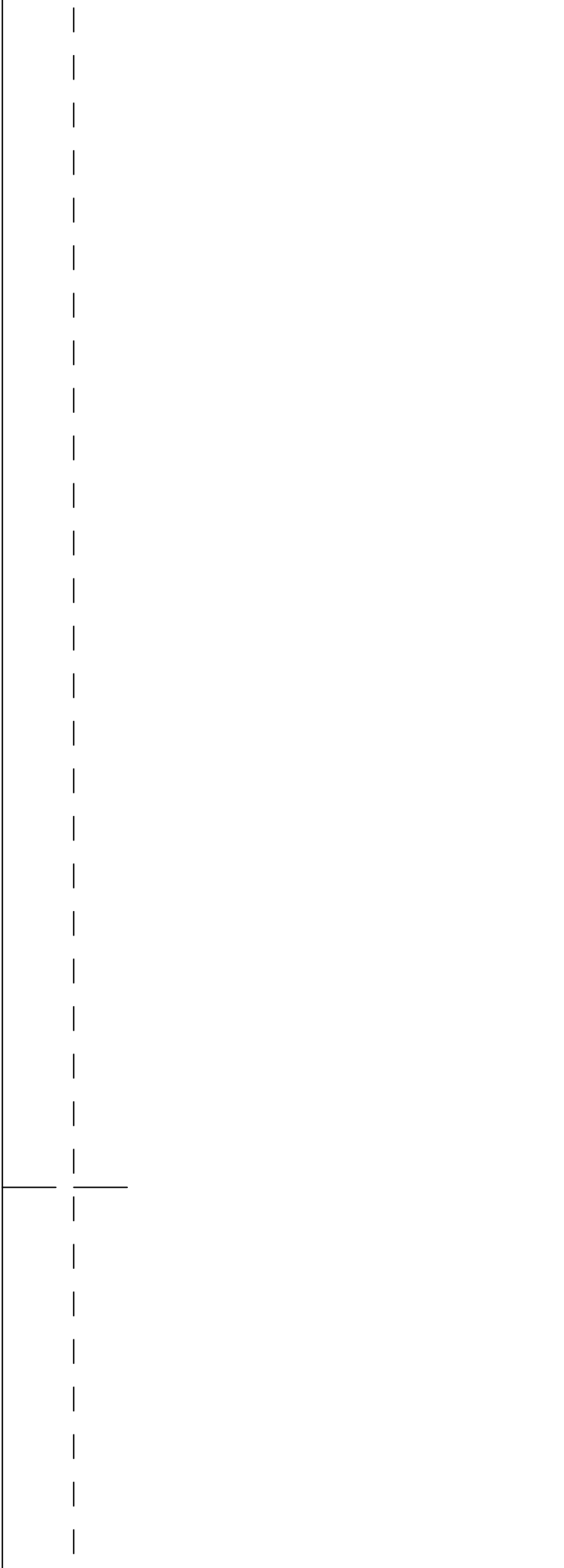

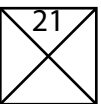
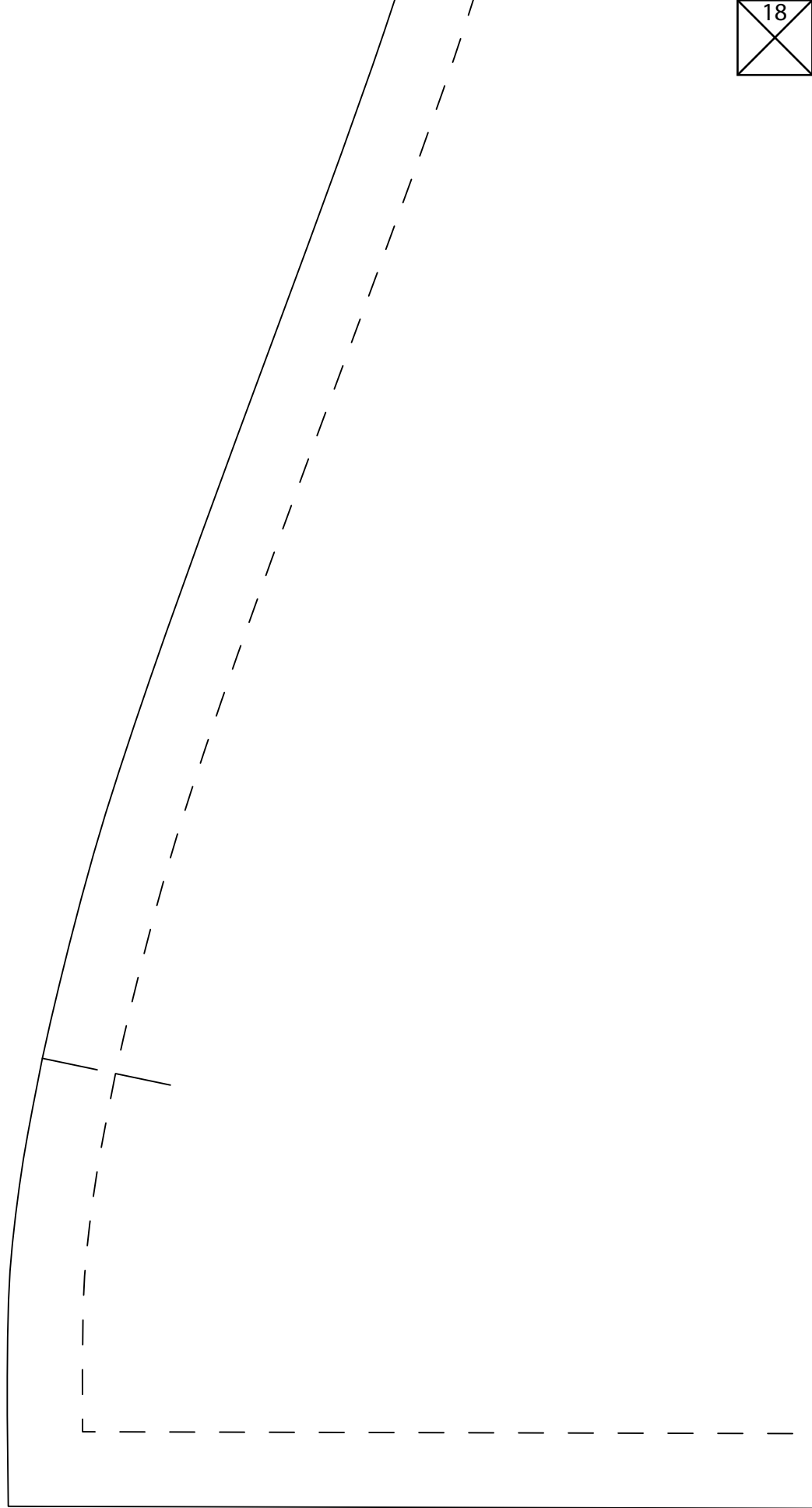
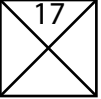

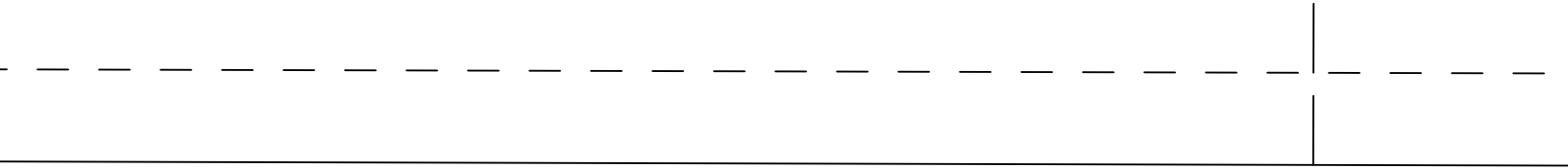
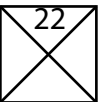
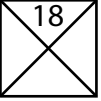

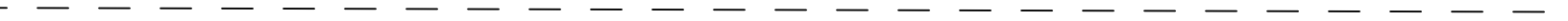
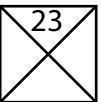
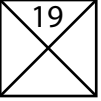

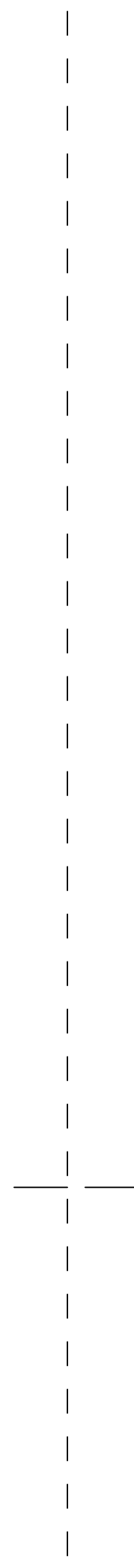
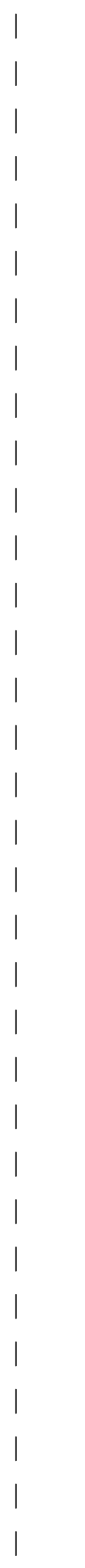
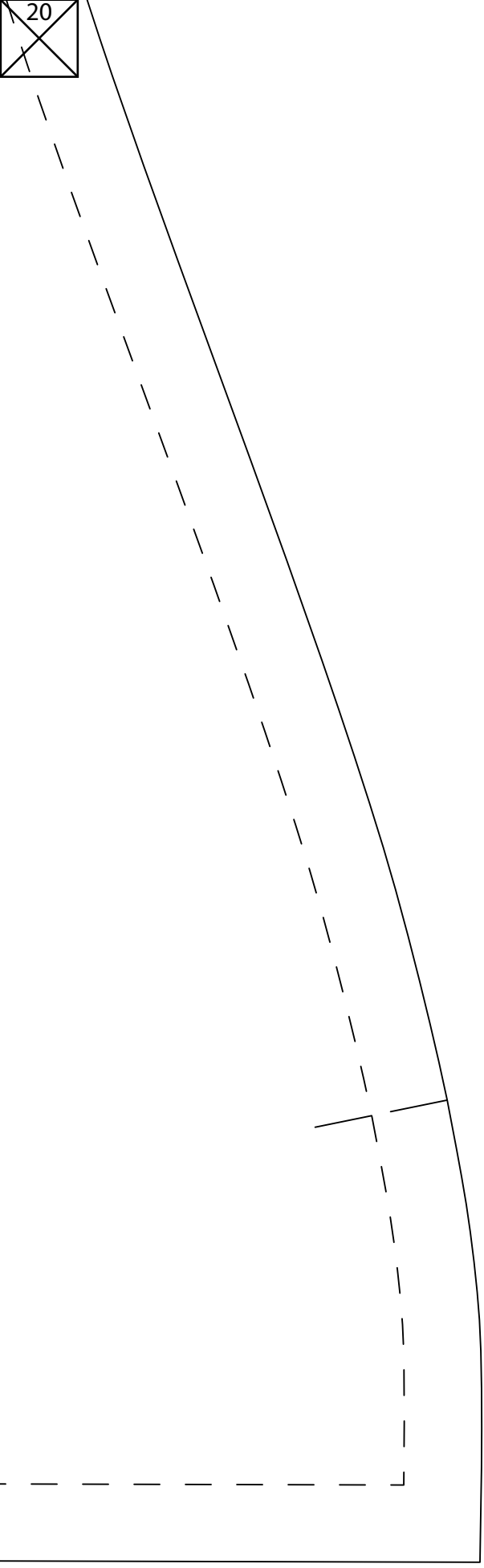
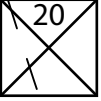

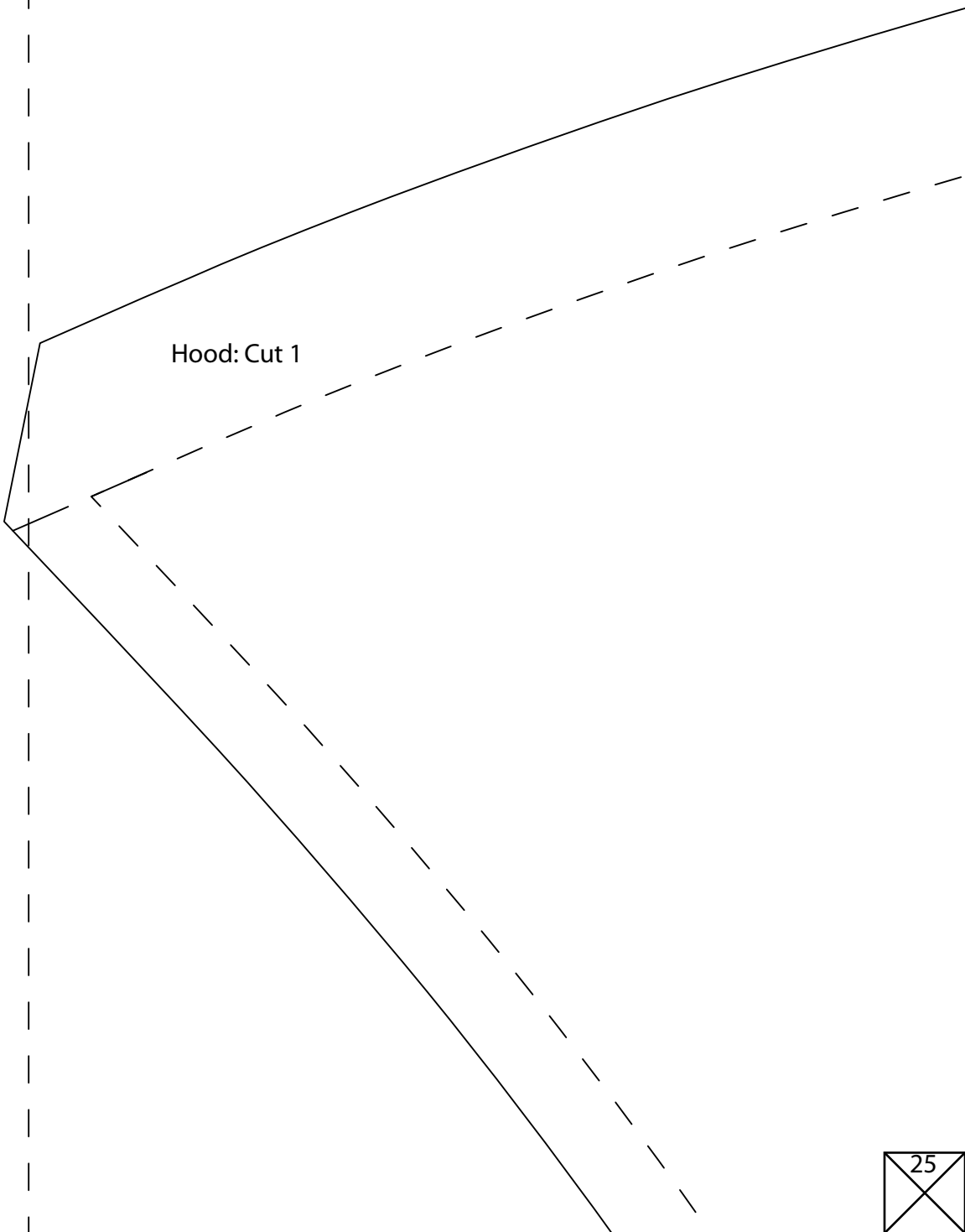
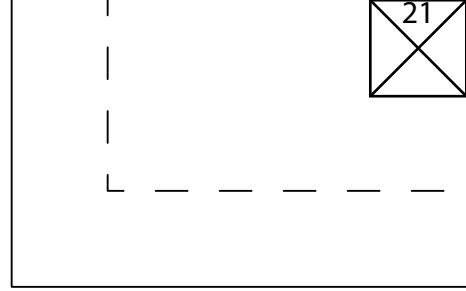

Hood: Cut 1

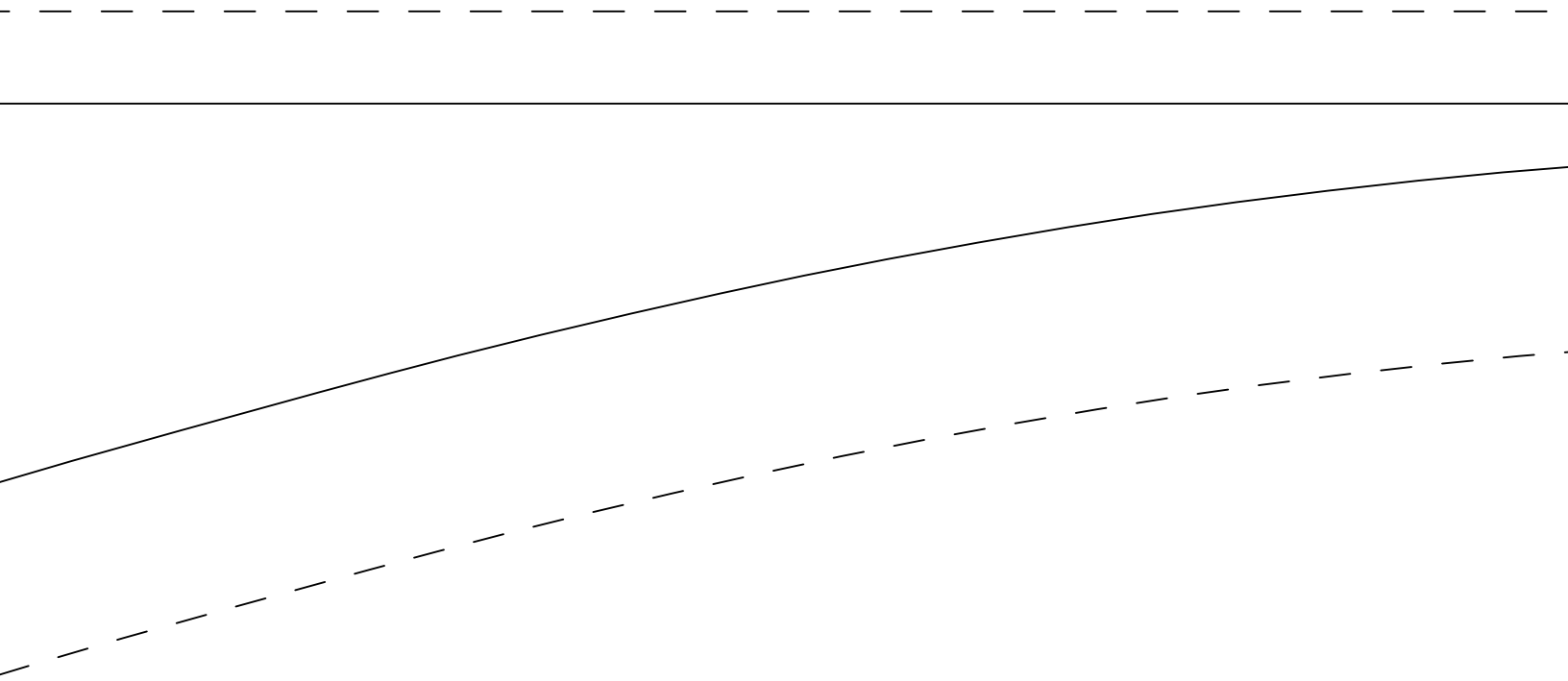
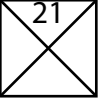

SEAM ALLOWANCES FOR THIS PATTERN: 1/2" except for the hood drawstring. Hood drawstring is 1". It is marked with a dashed line.
DISCLAIMERS:

Hopefully you'll get the gist of the matter; we shouldn't have to hire a lawyer to write this stuff up.

This pattern is not to be sold or exchanged but you can distribute it freely with the hopes you and others will.

No expressed warranty of this pattern is implied. That said, it has been checked and double checked down to the millimeter.

The design and instruction for the pattern of this coat project is by Carol Kimball & Carol Phillips.

Their site for this project which includes sewing instructions is <http://www.carolkimball.net/homeless-coat/>

There are also instructions there to draft your own pattern if you don't like this one.

This pattern print out was drafted by Kathleen Fasanella using StyleCAD software and further modified and checked.

Additional thanks to Ann Vong and Jasonda Desmond.

Online discussion for this coat can be found:

<http://www.fashion-incubator.com/archive/a-homeless-coat-pattern/>

<http://fashion-incubator.com/phpbb/viewtopic.php?p=54667#54667>

Any questions or commentary regarding this project should be directed to carol.kimball

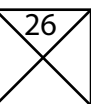
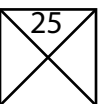

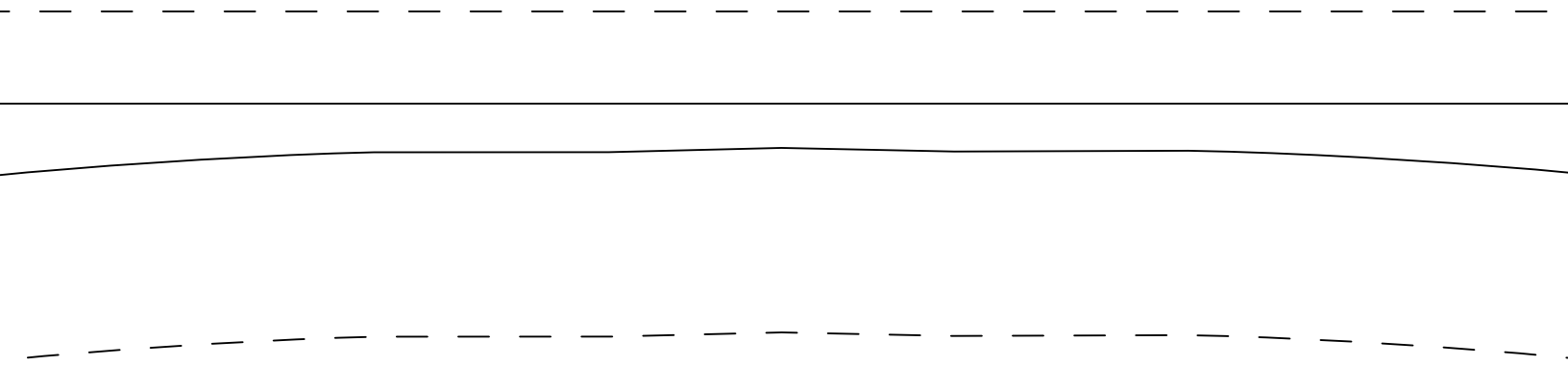
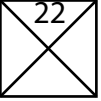

is marked with a dashed line.

thers will make coats for those less fortunate.
down to 1/64th" accuracy.

s-coat/

ed and edited in CS5.

